

BIANCO NXT

controls

811939	BIA-DRIVE1-15-240	811941	BIA-DRIVE1-15
811940	BIA-DRIVE1-22-240	811942	BIA-DRIVE1-22
		811943	BIA-DRIVE3-22
		811944	BIA-DRIVE3-40
		811945	BIA-DRIVE3-55
		811946	BIA-DRIVE3-75
812522	DRIVEPRO-22	811947	BIA-DRIVE3-110
812523	DRIVEPRO-37	811948	BIA-DRIVE3-150
		811949	BIA-DRIVE3-185
		811950	BIA-DRIVE3-220



1. Introduction

Congratulations on your new BIA DRIVE

The BIA DRIVE Series is designed for the Australasian market with both the end-user and the technician in mind. Featuring a handy setup wizard, programming has never been easier.

The full colour 100 x 55mm touch-screen interface ensures this Drive is simple to navigate for rapid access to clear, concise, system information. Displaying plain language fault codes and protection notices so you're always informed and in control.



Features





- Control and protect pumps up to 22kW
- Control up to 5 pumps (1 drive per pump) Master, Back-Up Master and up to 3 additional auxiliary drives via RS485 comms
- Variable frequency output for constant pressure control
- Minimise wasted energy and reduce the need for large pressure tanks
- 'Soft-starting' for low motor start current
- Timing group for sequencing up to 5 set points at pre-set times.
- Trip history (last 3 messages)
- 25 plain language fault messages
- Provides protection from: dry run, high and low voltage, input and output short circuits, high and low water pressure, input and output phase failure, high temperature and sensor faults
- 24V, 10V and 5V supply circuits
- Digital and analogue (voltage or current) inputs
- Relay and analogue outputs
- Multi-functional terminals

Part Number	Item Code	Voltage In	Voltage Out	kW	A	Protection
BIA-DRIVEPRO-22	812522	1 Phase 230V in	3 phase 230V out	2.2	10	IP54
BIA-DRIVEPRO-37	812523			3.7	17	
BIA-DRIVE1-15-240	811939	1 Phase 230V in	1 phase 230V out	1.5	7	
BIA-DRIVE1-22-240	811940			2.2	10	
BIA-DRIVE1-15	811941	1 Phase 230V in	3 phase 230V out	1.5	7	
BIA-DRIVE1-22	811942			2.2	10	
BIA-DRIVE3-22	811943			3 Phase 415V in	3 Phase 415V out	
BIA-DRIVE3-40	811944	3 Phase 415V in	3 Phase 415V out	4	9	
BIA-DRIVE3-55	811945			5.5	13	
BIA-DRIVE3-75	811946			7.5	17	
BIA-DRIVE3-110	811947			11	25	
BIA-DRIVE3-150	811948	3 Phase 415V in	3 Phase 415V out	15	32	
BIA-DRIVE3-185	811949			18.5	38	
BIA-DRIVE3-220	811950			22	45	
Part Number	Item Code	Description				
BIA-VMS-10BAR-TRAN	811953	Vertical Multi-stage pressure transducer 10 bar				
BIA-VMS-16BAR-TRAN	811954	Vertical Multi-stage pressure transducer 16 bar				
BIA-VMS-25BAR-TRAN	811955	Vertical Multi-stage pressure transducer 25 bar				

2. Contents

1.	Introduction	2
2.	Contents	3
3.	Symbols used in this manual	4
4.	Minimising EMI (Electromagnetic Interference).....	4
5.	Warnings and Cautions	5
6.	User Interface and Programming Quick Guide.....	6 - 7
7.	Operating Conditions	8
8.	Technical Specifications.....	9
9.	Function Descriptions.....	10
10.	Wiring.....	11
11.	Terminals	12
12.	Pressure Group Parameters – with notes	13
13.	Comm Group Parameters – with notes	16
13a.	Comm Group: Multi-Pump setup notes.....	17
14.	Pump Group Parameters – with notes.....	19
15.	Timing Group Setup notes	20
16.	I/O Group Parameters – with notes.....	21
17.	Periodic Maintenance	22
18.	Setup quick guide – (4-20mA input)	23
19.	Setup quick guide – Setup Wizard (4-20mA input).....	24
20.	Setup quick guide – Bore pump, constant pressure (4-20mA input).....	25
21.	Setup quick guide – Dual pumpset, constant pressure.....	25
22.	Setup quick guide – Triple pumpset, constant pressure.....	25
23.	Setup quick guide – ‘Soft Start’ without pressure control	25
24.	Setup quick guide – Speed control via external input.....	26
25.	Appendix 1: Pressure Group Parameter List.....	27
26.	Appendix 2: Comm Group Parameter List.....	28
27.	Appendix 3: Pump Group Parameter List.....	29
28.	Appendix 4: I/O Group Parameters	30
29.	Appendix 5: Alarm Codes and Solutions	31
30.	Warranties – Terms and Conditions	33

3. Symbols used in this manual

	Warning - Electrical safety
	Warning – Potential consequences of use outside of intended application(s). Includes environmental condition warnings.
	Mandatory warning
	Warning to disconnect power
	Read carefully

4. Minimising EMI (Electromagnetic Interference)

EMI Refers to unwanted electromagnetic signals or noise generated by the VFD or external sources, which can interfere with the proper functioning of electronic devices. VFDs, due to their rapid switching (e.g., in the IGBTs), can be significant sources of EMI, which can disrupt nearby sensitive equipment.

- To minimise the effect of EMI for signal conductors it is recommended to use Twisted Pair and Shielded cable.
- Alternately, use single conductors and twist to provide a balanced capacitance and inductive coupling thus cancelling out differential mode interference.









Installing shielded power cable is the most effective means to alleviate EMI problems. The cable's shield forces the noise current to flow directly back to the VFD before it gets back into the power network or takes other undesirable and unpredictable high frequency paths. Unlike signal wiring, the shielding on the motor cable should be terminated at both ends

- If shielded cable is not available then conductors plus ground in a conduit will provide some degree of protection.

Of all of the methods to mitigate EMC (Electromagnetic Compatibility) issues, grounding is the most effective and least costly. The importance of good grounding cannot be overstated.

The ground wire should be big (>3.5mm²) and short.

5. Warnings and Cautions

	Read the manual carefully before starting
	Prior to starting installation or maintenance the controller must be disconnected from the power supply. Allow 5 minutes for the internal electronics to discharge before opening the cover
	Any changes or modification to the wiring must be carried out by competent, skilled and suitably qualified personnel only.
	A qualified electrician should correctly size and install circuit breakers to protect the power supply. The fitment of additional surge protection is recommended.
	Never open the cover while controller is connected to electrical supply. Disconnect and allow 5 minutes for the internal electronics to discharge before opening the cover
	This appliance is not intended for use by persons (including children) with reduced physical, sensory or mental capabilities, or lack of experience and knowledge, unless they have been given supervision or instruction concerning use of the appliance by a person responsible for their safety. Children should be supervised to ensure that they do not play with the appliance.
	Ensure the controller is a suitable size for the pump motor Size according to the amperage required (P1 power)
	Avoid installing the BIA DRIVE where it could experience the following conditions: <ul style="list-style-type: none"> i. Where there is significant vibration and/or mechanical shock. ii. Where it could be exposed to corrosive liquids or gasses, or to flammable materials, solvents etc. iii. Extreme heat and cold. Operating range 0°C - 40°C. iv. Protect the controller from rain, moisture, humidity or dust

6. User Interface and Programming Quick Guide

The user interface provides access to three key groups of information: User, Installer and Programmer.

User Level: No password required

- Display screen summarises current operating conditions. Greater detail easily accessible.
- The screen saver duration can be set; the date and time can be altered and the fault log (last 3 faults) viewed.
- User screens are especially useful for monitoring system operation and diagnosing faults.

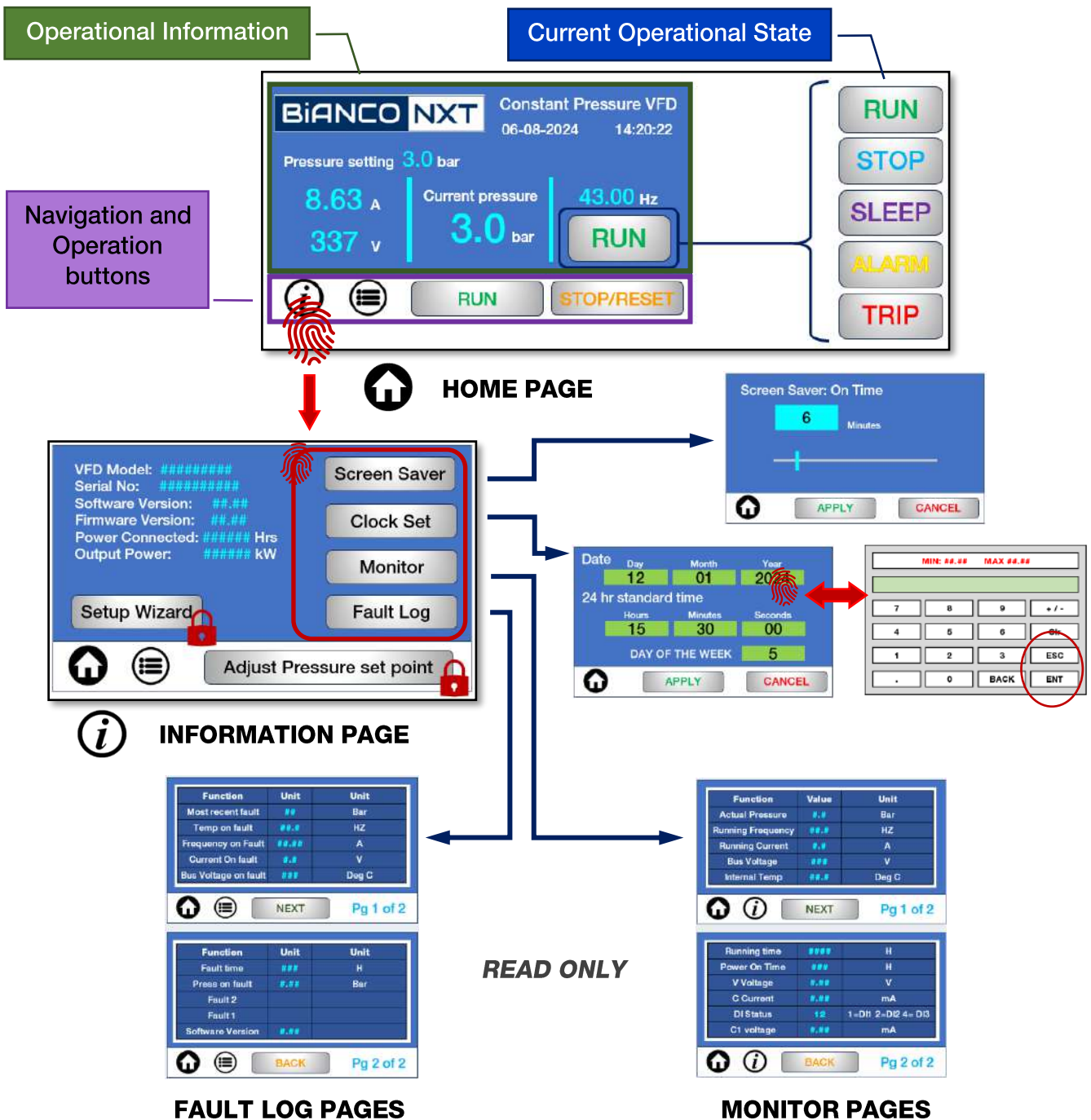

6a. User Interface and Programming Quick Guide con't

Installer Level: Password required

Access to the Setup Wizard and start / operational pressure set points.

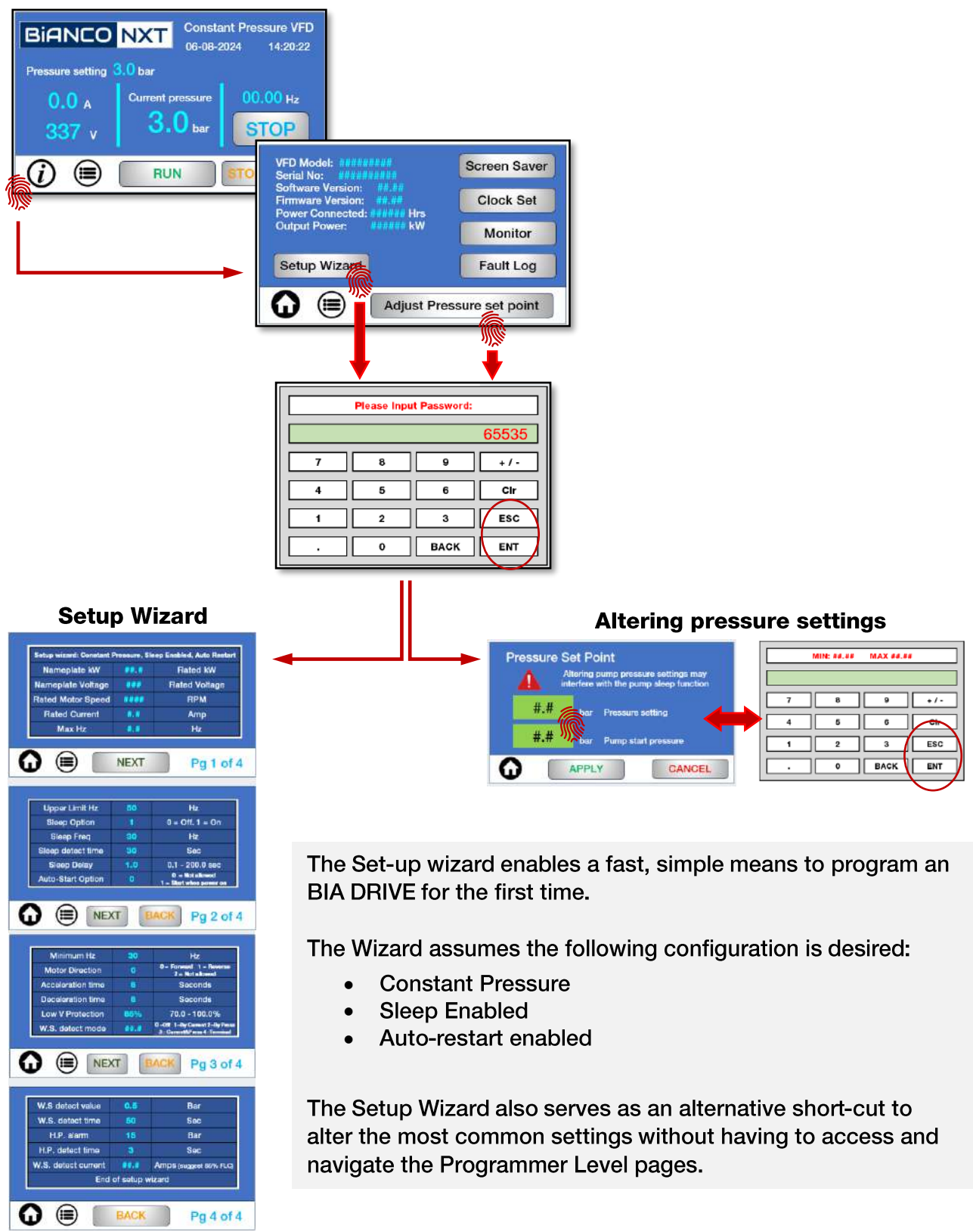

The Set-up wizard enables a fast, simple means to program an BIA DRIVE for the first time.

The Wizard assumes the following configuration is desired:

- Constant Pressure
- Sleep Enabled
- Auto-restart enabled

The Setup Wizard also serves as an alternative short-cut to alter the most common settings without having to access and navigate the Programmer Level pages.

6b. User Interface and Programming Quick Guide con't

Programmer Level: Password required

Access to a comprehensive suite of programming parameters.

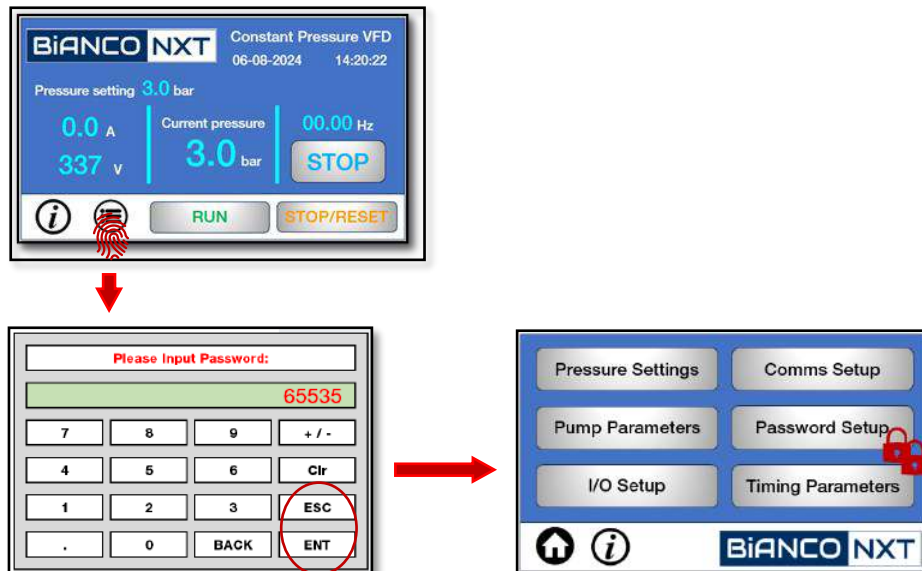

Accessing the Programming Level opens up six additional parameter groups.

Pressure settings: sensor setup and tuning, sleep functions, Low Pressure, High Pressure setup, PID setup and tuning and Alarm options

Pump Parameters: Motor setup, Rotation, Voltage, Current, Frequency, Start/Stop options

Input/Output Setup: V/Freq tuning, C/Freq tuning, Di setup, Mo and Relay output

Comms Setup: Comms settings and multi-pump setup

Password Setup: requires Level 2 password

Timing Parameters: Up to 5 stages. Timing function to set pump run cycles or pressure set point mode to allow for operation at alternative set point(s) at programmed times

7. Operating Conditions

Install out of direct sunlight and in a location free from dust, corrosive gases, inflammable gases, oil mist, steam and/or water droplets.

Environmental Temperature -10°C to +40°C.

Derate 4% output capacity every 1 °C above 40 °C up to a maximum of 50°C

Humidity ≤95%RH, no water condensation.

Vibration <5.9m / S2 (0.6G)

Altitude Lower than 1000m. Derate 1% capacity every 100m height increase over 1000m

8. Technical Specifications

Input & Output Parameters

- Start Frequency: 0.01-10.00Hz
- Input Voltage: 220VAC±15%,380V±15%
- Input Frequency Range 50/60Hz, fluctuation±5%
- Output Voltage ~ 0 to Rated input voltage
- Output Frequency ~ 0-200Hz

Function: Variable speed, Constant pressure Water supply

Control Mode: V/F control (constant torque)

- Starting Torque ~ 0.5Hz±100%
- Speed Adjustable Range ~ 1:100
- Speed-holding precision ~ ±1.0%
- Overload Capability ~ 150% rated current for 60s;180% rated current for 1s
- Acceleration/deceleration Time ~ 0.1-3600s

Peripheral Interface

- Programmable Digital Input: 2 means of digital terminal input
- Programmable Analog Input ~V: 0-5V V (remote pressure gauge):0-10V C (pressure transducer): 4-20mA
- Replay Output ~ 1 way output, programmable
- Open Collection Output~ 1 way output, programmable
- Command Running Channel ~ Three kinds of channels: 1. Operational panel 2.Control terminal 3.Serial communication port, choose 1 and 2 for master drive and 3 for auxiliaries
- Built-in PID ~ Advanced PID arithmetic to realize closed loop control system
- Stall Speed Control ~ Automatically limit current and voltage at running period to prevent tripping due to frequent overcurrent or overvoltage
- Master and Auxiliaries connection ~ Extensible RS485 design, one drive in the system can be master and controls the other auxiliary drives (4 at most) to work by communication mode. Master drive sends PID feedback information to the auxiliary drives and monitors status of auxiliaries in real time. Any failure of the auxiliary drives does not affect the others.

Controller Function

Multi-Pump Control:

1. Each pump requires an individual BIA DRIVE
2. Nominate one or two master controllers (2nd is standby master) and Max. 4 auxiliaries (standby master also works as auxiliary) to combine work. All the drives are connected through a RS485 Communication line.
3. Should the primary master controller fail, the standby master takes over to command the whole system. The master drives are (both) equipped with pressure transducers. Auxiliary drives do not require transducers.
4. The master detects pipe water pressure via the pressure transducer and communicates the signal to the auxiliaries, automatically controlling the auxiliaries to run or stop and PID status according to the water pressure condition.
5. Should the primary master controller fails to operate, the standby master will automatically replace the master to control the system. Should any auxiliary drive fails to operate, the system will just skip by and start the next controller, ensuring the automatic shift of pump group.
6. The pumps run alternately (8 hours by default) to balance every pump's running time to prolong service life of the whole pump-set.

9. Function Descriptions

	Action	Default						
Sleep Function Pressure Group Parameter #10 or Wizard	<p>When there is no water demand the pump will decelerate to the minimum frequency.</p> <p>Following a detection cycle the controller will enter sleep mode and stop the pump.</p> <p>When the pressure drops below the user-set parameter value the controller will wake up automatically and restart the pump.</p>	Valid						
Restart After Power On Pump Group Parameter #25 or Wizard	<p>In the event of a controller power interruption, with this setting VALID, normal operation will resume automatically when power is restored.</p>	Invalid						
Anti-seize Function Pressure Group Parameter #13. Tune parameters #24 - #26	<p>Rotating machinery such as pumps can develop mechanical issues if allowed to sit stationary for extended periods of time. Once this setting is made VALID, the pump will run briefly for a short period periodically to prevent internal corrosion, debris accumulation or lack of lubrication from causing issues</p>	Invalid						
Day-Part Control Timing Group	<p>Using the timing group, a day can be divided into blocks of time. The user can elect to prevent the pump running during a set time period OR set different operating pressures throughout the day</p>	Invalid						
Input Signals	<p>The controller can be accept up to 3 external inputs. Di3 is preset to accept a low water level (no-run) float input. Normally open circuit, float in the down position closed the circuit and prevents the pump(s) running</p> <table border="1" data-bbox="884 1308 1251 1559"> <tr> <td>Di 1 Option</td> <td>0 = Disabled 1 = Forward 2 = Reverse 3 = Fault Input 4 = Rapid stop 5 = Fault input 6 = PID closed</td> </tr> <tr> <td>Di 2 Option</td> <td>7 = Keypad Command 8 = Terminal Command 9 = Comm Command</td> </tr> <tr> <td>Di 3 Option</td> <td>10 = Fault Input is constantly closed 11 = Water Shortage</td> </tr> </table>	Di 1 Option	0 = Disabled 1 = Forward 2 = Reverse 3 = Fault Input 4 = Rapid stop 5 = Fault input 6 = PID closed	Di 2 Option	7 = Keypad Command 8 = Terminal Command 9 = Comm Command	Di 3 Option	10 = Fault Input is constantly closed 11 = Water Shortage	Invalid
Di 1 Option	0 = Disabled 1 = Forward 2 = Reverse 3 = Fault Input 4 = Rapid stop 5 = Fault input 6 = PID closed							
Di 2 Option	7 = Keypad Command 8 = Terminal Command 9 = Comm Command							
Di 3 Option	10 = Fault Input is constantly closed 11 = Water Shortage							
Outputs	<p>The controller has 2 x relay outputs and an open contact</p> <table border="1" data-bbox="884 1684 1251 1899"> <tr> <td>MO Output</td> <td>0 = Disabled 1 = Run status 2 = Fault 3 = FDT1 4 = FDT2</td> </tr> <tr> <td>Relay (TA, TB, TC)</td> <td>5: Run at 0 Freq 6 = Lower limit Freq Run 7 = Upper limit Freq Run</td> </tr> <tr> <td>Relay (TA1, TB1, TC1)</td> <td>8 = Standby 9 = Sleep 10 = Temp. Arrival</td> </tr> </table>	MO Output	0 = Disabled 1 = Run status 2 = Fault 3 = FDT1 4 = FDT2	Relay (TA, TB, TC)	5: Run at 0 Freq 6 = Lower limit Freq Run 7 = Upper limit Freq Run	Relay (TA1, TB1, TC1)	8 = Standby 9 = Sleep 10 = Temp. Arrival	Invalid
MO Output	0 = Disabled 1 = Run status 2 = Fault 3 = FDT1 4 = FDT2							
Relay (TA, TB, TC)	5: Run at 0 Freq 6 = Lower limit Freq Run 7 = Upper limit Freq Run							
Relay (TA1, TB1, TC1)	8 = Standby 9 = Sleep 10 = Temp. Arrival							

10. Wiring



Always use an electrical outlet that is protected by Residual Current Device (RCD) Safety Switch with a trip current of 30mA or less. A Safety switch is required by Australian/New Zealand Standard AU/NZS 60335.1-20

- Install with a suitably rated circuit breaker
- All wiring must be carried out by a suitably qualified technician.

Note: Never connect AC power to U,V,W terminals.

Never install capacitors or surge current absorber (piezo-resistors) to the drive output side. These can cause the drive to burn out.

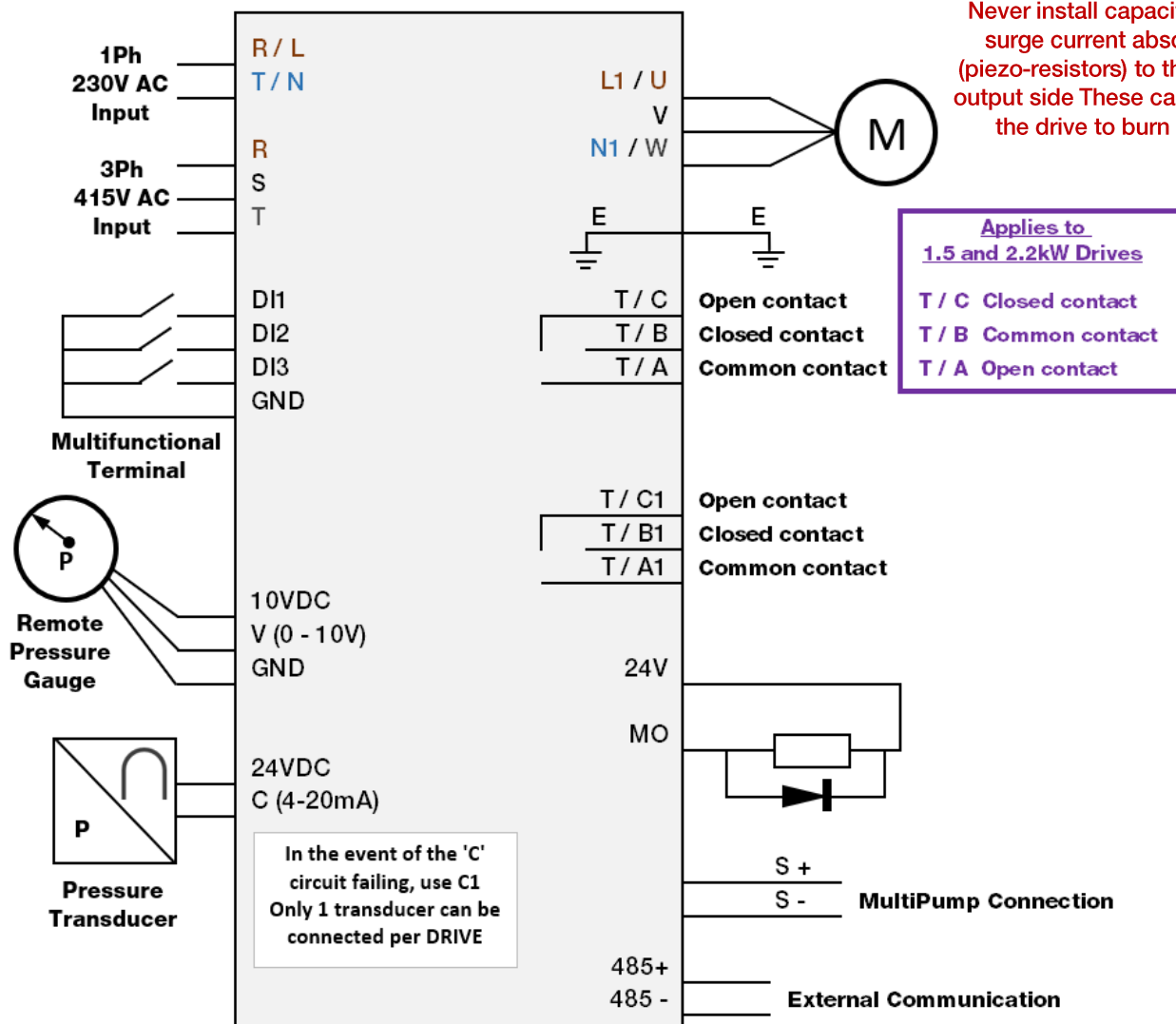

Power must be off for at least 10 minutes and isolated before wiring and inspection to avoid the risk of electric shock.



Ensure high voltage wiring terminals are connected tightly to avoid damage on the device due to loose connections or arcing.



Take care than no foreign objects are left inside the drive i.e. wire fragments, solder, metal, etc which could cause a short circuit and damage the drive.

11. Terminals

Terminals for 4.0W to 22kW BIA DRIVE

485+	485-	S+	S-	V	C	C1	+24V	DI1	DI2	DI3	T/A	T/B	T/C
	A01	GND	+10V	+5V	GND	COM	+24V	COM	MO	COM	T/A1	T/B1	T/C1

Terminals for 0.75kW and 2.2kW BIA DRIVE

										24V	C	GND	
TA	TB	TC	MO	24V	GND	DI2	DI1	V	C	10V	5V	S-	S+

Terminal Name	Description
DI1, DI2, DI3	Digital input 24V GND Input voltage: 9-30V, input resistance: 10K Ω
V	Analog input, voltage: 0-10V, input resistance: 6.8K Ω
C	Analog input, current: 4-20mA, input resistance: 5000
C1	<i>Analog input, current: 4-20mA, input resistance: 5000</i> Backup circuit should 'C' fail
10V	10V supply, output current: 0-100mA
GND	Zero reference level for 5V, 10V, 24V
MO	Open contact. Common terminal: GND, Input: 0-24V, 0-50mA
24V	Power Supply
5V	Power Supply
T/A, T/B, T/C T/A1, T/B1, T/C1	For 4-22kW Relay output: T/A, T/C Open, T/A, T/B Closed, T/A1, T/C1 Open, T/A1, T/B1 Closed. Contact capacity: AC250V / 3A, DC30V / 1A
T/A, TB, T/C	For 1.5kW and 2.2kW Relay output: T/A, T/B open, T/B, T/C closed Contact capacity: AC250V / 3A, DC30V / 1A
S+, S-	Multi-pump control connection
485+, 485-	External signal terminals
A01 (4 – 22kW only)	Analogue Output 0-10V, GND

Program parameter hierarchy

	Essential parameter – input value for motor and essential operating options
	Important parameters – alter according to site specific requirements
	Common fine-tuning parameters
	Parameters to access advanced options.
	Advanced settings. Alter with care as unexpected behaviours may occur

12. Pressure Group Parameters – with notes

Pressure Group: 34 parameters, 6 pages			
	Function	Set Range	
1	Set Press	0.0 - 60.0 Bar Default 3.0 Bar	Desired operating pressure
2	Start Press	0 – U0 - 00 Bar Default 2.4 Bar	Pump start pressure
Acceleration/Deceleration rates are managed in the PUMP GROUP Parameters			
3	Sensor Type	0 = (0 - 10V) 1 = (4-20mA: C) 5 = (4-20mA: C1) Default = 1	Outlet pressure sensor type
4	Sensor Range	0.0 - 60.0 Bar Default 10 Bar	Outlet pressure sensor range
5	Pressure correction	0 - 2.000 Default = 1.000	Digital pressure value offset
Parameter #5 allows the user to apply an offset so the digital reading agrees with an analogue pressure gauge			

SLEEP FUNCTION [Parameters 6,7,9,10,11 and 26]

In normal operation, the Drive references the pressure value. Once the pressure reaches the target pressure [Parameter #1] the Drive will reduce the frequency to see what happens.

If the pressure falls, the Drive logic determines water use is occurring and will adjust speed to achieve the target pressure again.

If the pressure remains within range, the Drive will check/adjust 2 more times. If pressure remains within tolerance despite reducing pump speed, the Drive will determine there is no water consumption and should go to sleep.

6	Frequency drop time	0.0 – 100 (0 = Off) Default = 1	Do not alter
7	Sleep Detect Time	3 – 6000 sec Default = 30 sec	Time period of speed reducing checks
8	Water shortage detect mode	0 = Off 1 = By Current 2 = By Press. 3 = By Current and Press. 4 = Terminal Default = 2	Select the means by which the controller will determine when there is insufficient water available. Set Parameters 15–18 according to the method selected
9	Leakage factor	0 – 10.0 Default = 1.0	Allowable pressure drop in system before the pump(s) exit sleep mode and resume operation. A larger value allows greater pressure drop
10	Sleep Option	0 = OFF 1 = ON Default: 1 = ON	~
11	Sleep Frequency	0.00Hz – 100 Hz Default = 35Hz	See below

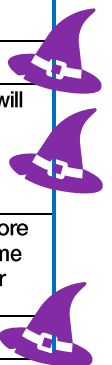

Parameter #11 is the frequency at which the pump begins the sleep test cycle after the time period programmed at Parameter #26. The pump must be able to maintain its set pressure [Parameter 1] at this speed setting. Ensure that the parameter #11 value is greater than the **PUMP GROUP / Parameter #15 [Lower Limit Frequency]** value

12	Anti-freezing / rust	0 = OFF 1 = ON Default: 1 = ON	As above
13	Sensor off value	0.0 - 100.0% Default = 5.0	~
14	Sensor off time	0.0 - 3000.0 sec Default = 10 sec	~
15	Water shortage detect value	0 – 200 Bar (L.P. setting) Default = 0.5 bar	Valid when Parameter #8 = 2 or 3
16	Water shortage detect frequency	00.0 - 99.99 Hz Default = 45 Hz	~
17	Water shortage detect delay	0.1 - 999.9 sec Default = 50 sec	Ignore time when Parameter #8 condition is valid
18	Water shortage current.	Model Dependent, Suggest 85% FLC	Valid when Parameter #8 = 1 or 3
19	High Pressure alarm	0 - 200.0 Bar Default = 15 Bar	H.P Alarm setting
20	High Pressure detect time	0.1 - 200.0 sec Default = 3 sec	Duration before triggering an alarm state
21	Low Pressure alarm	0.0 - 60.0 Bar Default:0 = Off	L.P Alarm setting
When P#8 [Water Shortage Detect Mode] is set to Value 2 or 3 (referencing pressure), P#21 [Low Pressure alarm] value must be set lower than or equal to P#15 [Water Shortage Detect Value]			

ANTI SEIZE / RUST FUNCTION [Parameters 12, 24 – 26]

Water pumps, especially those that are not in continuous operation, can be prone to mechanical seizing due to corrosion or rust build-up. When metal components corrode over time, there is a greater likelihood of increased friction or complete seizure.

These settings cause the pump to run periodically for a short time at low rpm to mitigate the risk of seizure

WATER SHORTAGE FUNCTION [Parameters 8,15 – 18 and 21]

BIA DRIVE provides a function which allows the user to select the means by which the controller determines a lack of water [Parameter #8]. This may be turned off. The default setting is by (low) pressure but the user may elect to use current or a combination of both.

Alternately, by selecting **P#8 = Value 4 [Terminal]** a switched input such as a float can be connected to one of the three normally-open DI (direct input) terminals

Whenever the drive detects a signal or condition outside of the water shortage programmed values, the pump will shut down automatically. After set time period it will restart to check that pressure can restore to normal, If pressure does not re-establish, the drive will shut down again and repeat the cycle.

22	Low Pressure detect time	0.1 - 6000.0 sec Default = 60 sec	Time period Pressure must be less than or equal to P#21
23	Anti-Freezing cycle	3 - 60000 min Default = 1500 min	Period of inactivity before commencing an anti-freeze cycle
24	Anti-Freezing time	0 - 6000 sec Default = 10 sec	Duration of the anti-freeze cycle
25	Anti Freezing freq	00.00 - 99.99 Hz Default = 30 Hz	Anti-freeze rotation speed
26	Sleep delay	0.1 - 200.0 sec Default = 1.05 sec	Related to Parameter 11 – Sleep frequency
27	Kp1	0.0 - 50.0 Default = 3.0	~
28	Integral Time 1	0.1 - 100.0 sec Default = 1 sec	~
29	Kp2	0.0 - 50.0 Default = 3.0	~
30	Integral Time 2	0.1 - 100.0 sec Default = 2 sec	
31	PID Change Deviation	0 - 100% Default = 60%	~



PID refers to a common control logic comprising three elements: Proportional, Integral, and Derivative.

1. Proportional Term: This term calculates the error value, which is the difference between the desired Set Point [SP] and the actual Process Value [PV], multiplied by a proportional gain factor [Kp]. The result [e(t)] represents the immediate error value and directly influences the controller's response to bring PV closer to SP.
2. Integral Term: This term considers the cumulative error over time. By summing past error values, it corrects for any persistent steady-state errors that the proportional term alone cannot eliminate. $\frac{de(t)}{dt}$
3. Derivative Term: This term evaluates the rate of change of the error over time. It anticipates future error trends, which helps dampen rapid fluctuations and improves stability, especially when the system undergoes abrupt changes.

The controller uses these three methods to automatically correct the Process Value and achieve the Set Point:

- Proportional (P) Component: Responds to the current error by producing an output proportional to its magnitude, providing immediate correction based on the current distance from SP.
- Integral (I) Component: Addresses cumulative past errors to eliminate any remaining steady-state discrepancies over time.
- Derivative (D) Component: Predicts future error trends by assessing the rate of error change, helping to prevent overshoot and enhancing stability during rapid system changes.

KEY PARAMETERS:

Kp (Proportional Gain) defines the strength of the response.

Integral Time determines the speed at which the cumulative correction is applied.

Derivative Time (also known as PID Change Deviation) is particularly useful for damping responses in fast-acting systems, though it has a lesser effect in slower systems like pumping applications.

TUNING:

Tuning the PID parameters for system response and stability is a largely intuitive process.

Document initial values before adjustment, so settings can be reverted if needed

Make gradual changes.

32	Alarm reset occurrences	0 – 1000 Default = 200	Number of times the drive will reset alarm occurrences when P#34 is valid. Once the P#34 value is exceeded, the drive will remain inactive in an alarm state
33	Alarm reset time	0 – 60000 min Default = 10 min	Delay period before resetting an alarm when P#34 is valid.
34	Alarm reset option	0 = OFF 1 = ON Default:1 = ON	Option to automatically reset an alarm condition

13. Comm Group Parameters – with notes

Communication Group: 10 parameters, 2 pages			
Item	Function	Set Range	Default
1	Comm Address	1,2 for master; 3-5 for slave	1
2	Alternation Time	0-60000 Min	480 min
3	Slave Qty	0 - 4	0
4	Multi pump control	0 = Master/slave control 1 = Simultaneous	0
5	Pump adding delay	0.1-600.0 sec	1.0 sec
6	Pump reducing delay	0.1-600.0 sec	0.1 sec
7	Standby Pump delay	0.1-600.0 sec	5.0 sec
8	Baud Rate for Comm	5 = 9600 6 = 19200 7 = 38400	6
9	External address	0 - 247	1
10	External baud rate	5 = 9600 6 = 19200 7 = 38400	5

13a. Comm Group: Multi-Pump setup notes

Multi-Pump Control:

1. Each pump requires an individual BIA DRIVE
2. All the drives are connected through a communication line.
3. Nominate either one or two master controllers. The 2nd acts as a standby master.
4. A maximum of 4 slave controllers can be added. If a standby master is nominated, it also operates as an auxiliary to combine work.
5. Should the primary master controller fail, the standby master will take over to command the whole system. To operate as a master drive, the controller(s) must have a with pressure transducer connected. Auxiliary drives do not require transducers.
6. The master detects pipe water pressure via the pressure transducer and communicates the signal to the auxiliaries, automatically controlling the auxiliaries to run or stop and their PID status according to the water pressure condition.
7. Should the primary master controller fail to operate, the standby master will automatically replace the master to control the system. Should any auxiliary drive fail to operate, the system will just skip past and start the next controller, ensuring the automatic shift of the pump group.
8. The pumps run alternately (8 hours by default) to balance every pump's running time to prolong service life of the whole pump-set. **COMM GROUP / Parameter #2 [Alternation time]**

Use shielded twin-core cable to connect S+ to S+ and S- to S- in parallel from one drive to the next before setting parameters.

(1) One master pump setting:

Pump 1	Master controller	
COMM GROUP Parameters		
#4	Multi Pump Control 0 = Master / Slave	0
#1	Comm Address (Master)	1
#3	Slave Quantity Set according to system	0 - 4

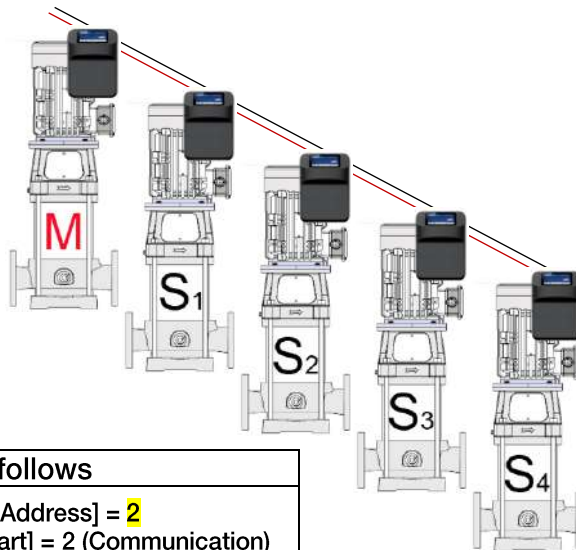

Set every slave controller as follows	
Pump 2 Slave 1	COMM GROUP / Parameter #1: [Comm Address] = 2 PUMP GROUP / Parameter #9: [Stop/Start] = 2 (Communication) PUMP GROUP / Parameter #10: [Freq Input] = 2 (Communication)
Pump 3 Slave 2	COMM GROUP / Parameter #1: [Comm Address] = 3 PUMP GROUP / Parameter #9: [Stop/Start] = 2 (Communication) PUMP GROUP / Parameter #10: [Freq Input] = 2 (Communication)
Pump 4 Slave 3	COMM GROUP / Parameter #1: [Comm Address] = 4 PUMP GROUP / Parameter #9: [Stop/Start] = 2 (Communication) PUMP GROUP / Parameter #10: [Freq Input] = 2 (Communication)
Pump 5 Slave 4	COMM GROUP / Parameter #1: [Comm Address] = 5 PUMP GROUP / Parameter #9: [Stop/Start] = 2 (Communication) PUMP GROUP / Parameter #10: [Freq Input] = 2 (Communication)

(2) Two master pump setting:

Pump 1 Master controller	
COMM GROUP Parameters	
Multi Pump Control 0 = Master / Slave	0
Comm Address (Master)	1
Slave Quantity Set according to system	0 - 4

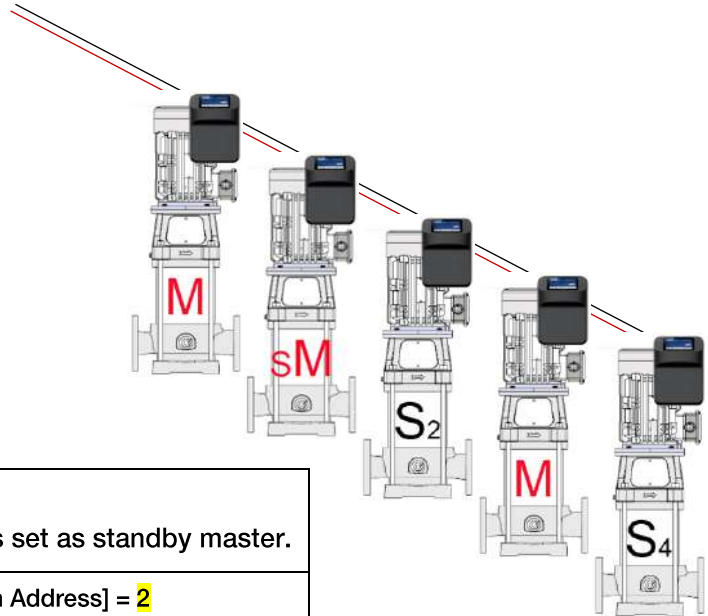

Pump 2 Standby Master controller	
Pump 2 must be connected to sensor when it is set as standby master.	
Standby Master and Aux	COMM GROUP / Parameter #1: [Comm Address] = 2 PUMP GROUP / Parameter #9: [Stop/Start] = 2 (Communication) PUMP GROUP / Parameter #10: [Freq Input] = 2 (Communication)

Set slave controllers as follows	
Pump 3 Slave 2	COMM GROUP / Parameter #1: [Comm Address] = 3 PUMP GROUP / Parameter #9: [Stop/Start] = 2 (Communication) PUMP GROUP / Parameter #10: [Freq Input] = 2 (Communication)
Pump 4 Slave 3	COMM GROUP / Parameter #1: [Comm Address] = 4 PUMP GROUP / Parameter #9: [Stop/Start] = 2 (Communication) PUMP GROUP / Parameter #10: [Freq Input] = 2 (Communication)
Pump 5 Slave 4	COMM GROUP / Parameter #1: [Comm Address] = 5 PUMP GROUP / Parameter #9: [Stop/Start] = 2 (Communication) PUMP GROUP / Parameter #10: [Freq Input] = 2 (Communication)

Double Master pump alternation

Pump 1 controller and Pump 2 controller must each have a sensor connected

1. The master pump status is shifted from Pump 1 to Pump 2 under the following circumstances:
 - a) Comm signal is off between Pump1 and Pump2
 - b) Pump 1 sensor at fault protection status
 - c) Pump 1 is damaged.
2. Pump 2 controller operates as master pump until the above (a.b.c.) are resolved. Pump 1 controller will resume master pump status again only after switching power off and on.
3. While running, the master pump status shifts to Pump 2 only when Pump 1 signal is off.

After cycling power, Pump 2 controller must receive a signal from Pump 1 to determine whether it assumes master pump status or not.

Note: In the one master pump system, if Pump 1 has problems such as phase loss, overvoltage, undervoltage protection, the other slave pumps operate normally.

14. Pump Group Parameters – with notes

Pump Group 32 parameters, 6 pages			
Item	Function	Set Range	Default
1	Initialization	0 - 9999	0
2	Motor Rated Power	1 - 1000 kW	Set according to motor nameplate
3	Motor Rated Speed	1 - 10000 rpm	
4	Motor Rated Voltage	1 - 800 V	
5	Motor Rated Current	01 - 1000.0 A	
6	Rotation Direction	0 = Forward 1 = Reverse 2 = Not allowed	0
7	Stop method	0 = Stop by deceleration 1 = Natural Stop	0
8	Low voltage Protection	70.0 -100.0 %	100.00%
9	Stop and start command	0 = Keypad 1 = Terminal 2 = Communication	2
10	Frequency given	0 = UO-14 1= PID 2 = Com. (Slave Com2) 3 = External control (0-10v) 4 = External control (4 – 20 mA) 5 = C1 (4 – 20mA)	1
11	Acceleration time	0.1 - 6000.0 S	8.0 sec
12	Deceleration time	0.1 - 6000.0 S	8.0 sec
13	Max Frequency	5.00 – 200Hz	50.00 Hz
14	Upper limit Frequency	5.00 – 200Hz	50.00 Hz
15	Lower limit Frequency	5.00 – 200Hz	0.0 Hz
16	Hand Input Frequency	0.00 – 200Hz	50.00 Hz
17	Carrier Frequency	1 - 12	6
18	Output phase loss protection	0 = Off 1 = On	1
19	Motor overload Gain Protection	20.0 – 1000.0%	100.0%
20	Torque Boost	0 - 20%	Model dependent
21	GND short circuit protection	0 = Off 1 = On	1
22	Overcurrent stall gain	0-100.0 sec	20 sec
23	Overcurrent stall current	100.0 - 200.0%	160.0%
24	Overvoltage stall / Overvoltage protection	110 – 145%	130%
25	Auto Start option	0 = Not allowed 1 = Start when power on	0
26	Auto Start delay when power is on	0 – 100.0 sec	1.0 sec
27	Fault Reset attempts	0 - 20	3
28	Fault Reset Time	0.1-100.0 sec	10.0 sec

29	Quick reducing Current	0 = Off 1 = On	1
30	Input phase loss protection	0 = Off 1 = On	1
31	Motor type selection	0 = Asynchronous motor 1 = Permanent magnet synchronous	0
32	Motor rated Frequency	50 Hz	Set according to motor nameplate

15. Timing Group Setup notes



Timing Work: the controller will ONLY operate at the times and pressure(s) set at each stage

Press Set Mode: the controller operates for the programmed time and at the pressure programmed at that stage. Outside of the programmed stages, the controller operates normally, on demand at the pressure set at

PRESSURE GROUP, Parameter 1.



Select the mode

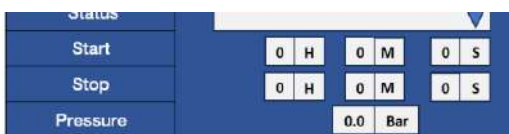

Set Start/Stop times and pressure

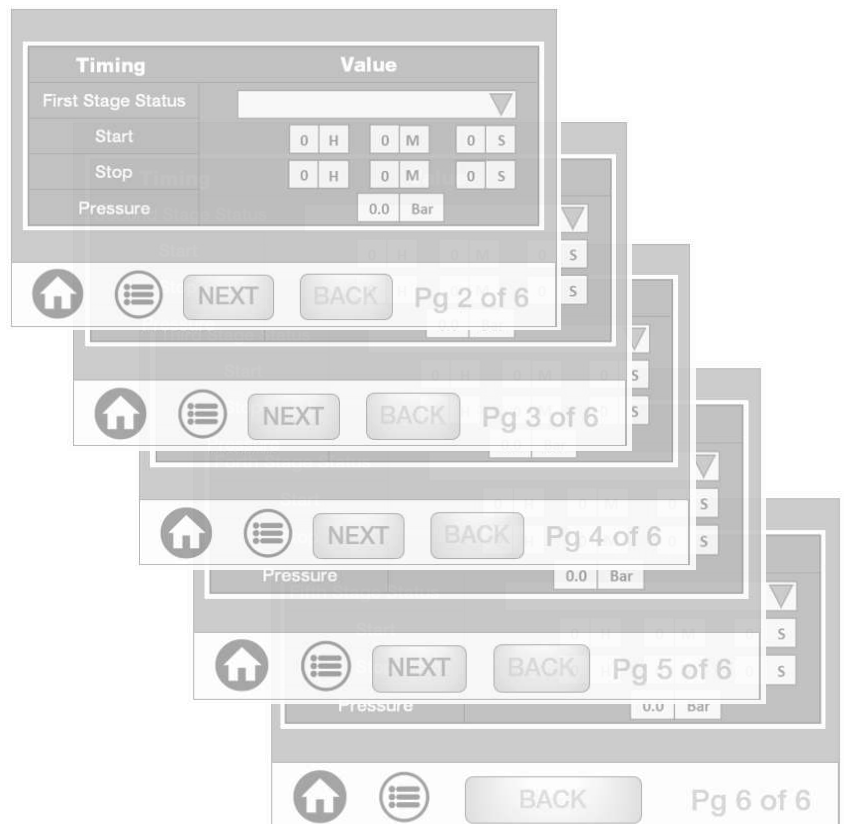

Once programming is complete, the 1st page of the timing group shows how many Stages are active AND which Mode they are set to.

16. I/O Group Parameters – with notes

Input / Output Group 25 parameters, 5 pages			
Item	Function	Set Range	Default
1	Min V	0.00 – 10.00	0.00
2	Min V Freq	0.0 – 100%	0.0%
3	Max V	0.00 – 10.00	10.00
4	Max V Freq	0.0 – 100%	100%
5	V Filter time	0.01 – 10.00 sec	0.05 sec
6	Min C	0.00 – 20.00	4.0
7	Min C Freq	0.0 – 100.0%	0.0%
8	Max C	0.00 – 20.00	20.00
9	Max C Freq	0.0 – 100.0%	100.0%
10	C Filter time	0.01 – 10.00 sec	0.05 sec
11	Di 1 Option	0 = Disabled 1 = Forward 2 = Reverse 3 = Fault input 4 = Haste stop 5 = Reset 6 = PIO closed 7 = Keypad command 8 = Terminal command 9 = Com command 10 = Fault input normally closed 11 = Water shortage	11
12	Di 2 Option		
13	Di 3 Option		
14	Mo Output	0 = Disabled 1 = Run Status 2 = fault 3 = FDT1 4 = FOT2 5 = Run at 0 freq. 6 = Lower limit freq. run 7 = Upper limit freq run 8 = Standby 9 = Sleep 10 = Temp Arrival	11
15	Relay (TA, TB, TC)		
16	Relay (TA1, TB1, TC1)		
17	Di1 valid delay	0.0 – 3600.0 sec	0.0 sec
18	Di1 invalid delay	0.0 – 3600.0 sec	0.0 sec
19	Di2 valid delay	0.0 – 3600.0 sec	0.0 sec
20	Di2 invalid delay	0.0 – 3600.0 sec	0.0 sec
21	Di3 valid delay	0.0 – 3600.0 sec	0.0 sec
22	Di3 invalid delay	0.0 – 3600.0 sec	0.0 sec
23	MO output delay	0.0 – 3600.0 sec	0.0 sec
24	Relay Delay	0.0 – 3600.0 sec	0.0 sec
25	Relay1 Delay	0.0 – 3600.0 sec	0.0 sec

17. Periodic Maintenance

Operation can suffer if the controller suffers over-heating. Ambient temperature should be maintained in the range 0-40 deg C and humidity between 20 to 90%.

Over the life of the controller, a build-up of dust or dirt can result in the controller operating at a higher temperature than normal.

The controller should be installed where airborne dust is minimised.

The cover should be removed periodically and vacuum or low pressure air used to remove any build-up of dust or dirt especially on the PCB's, on the fans and on the cooling plate/heatsink fins.

While the cover is removed, check the control terminal screws are tight.

The BIA DRIVE controllers are fitted with cooling fans to assist with controlling temperature. If the operation of the fan is compromised or the fan has failed, abnormal operation may result.

- Fans and capacitors are considered wearing parts.
- Expected fan life = 20,000 hours running.
- Expected capacitor life = 30 – 40,000 hrs running,
- Abnormal appearance, colour or smell indicates that the capacitor should be replaced

Checking operating hours:

The screenshots show the BIANCO NXT VFD control interface. The first screen displays the main status: Pressure setting 3.0 bar, 0.0 A, 337 V, and Current pressure 00.00 Hz. The second screen shows VFD details: VFD Model, Serial No, Software Version, Firmware Version, Power Connected, and Output Power, along with navigation buttons like Screen Saver, Clock Set, Monitor, Fault Log, Setup Wizard, and Adjust Pressure set point. The third screen is a table of operating parameters:

Function	Value	Unit
Actual Pressure	##	Bar
Running Frequency	##.#	HZ
Running Current	##	A
Bus Voltage	###	V
Internal Temp	##.#	Deg C

The fourth screen shows a table of operating parameters with the first two rows highlighted in red:

Running time	###	H
Power On Time	###	H
V Voltage	##.#	V
C Current	##.#	mA
DI Status	12	1=DI1 2=DI2 4= DI3
C1 voltage	##.#	mA

18. Setup quick guide – (4-20mA input)

The DRIVE-PRO cabinets include a pre-wired terminal strip

- Connect the incoming power supply
- Connect the wiring to the pump motor
- Connect the pressure transducer



To access the terminals inside the DRIVE, the lower front cover must be removed.



A full list of terminals and their functions can be found on Page 12.

Ensure the installation meets the minimum requirements as shown below

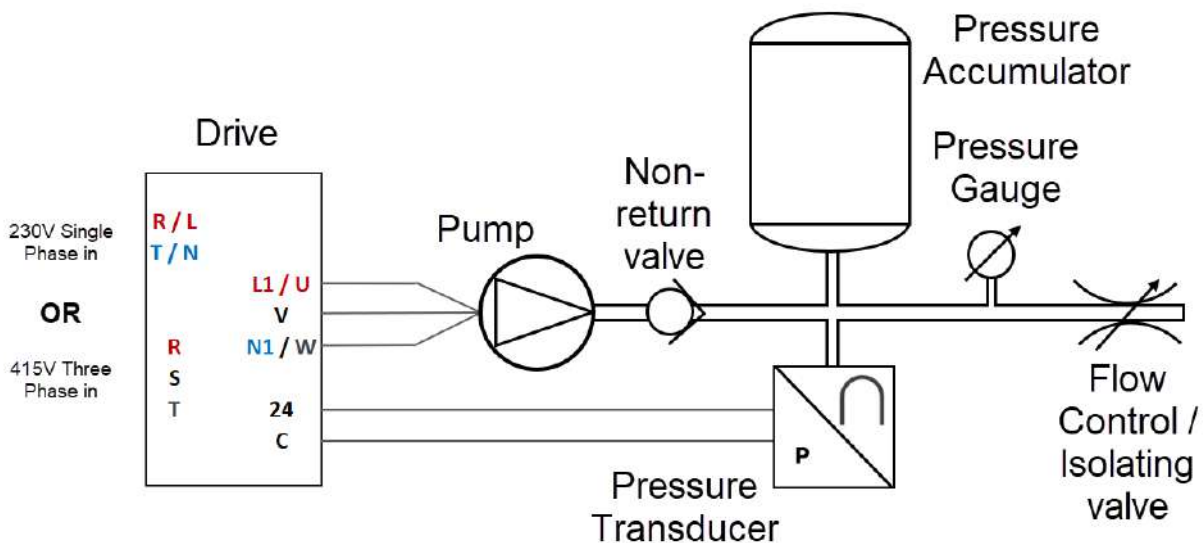

19. Setup quick guide – Setup Wizard (4-20mA input)

As the bare minimum, **EVERY** Drive requires programming via the Set-Up Wizard.

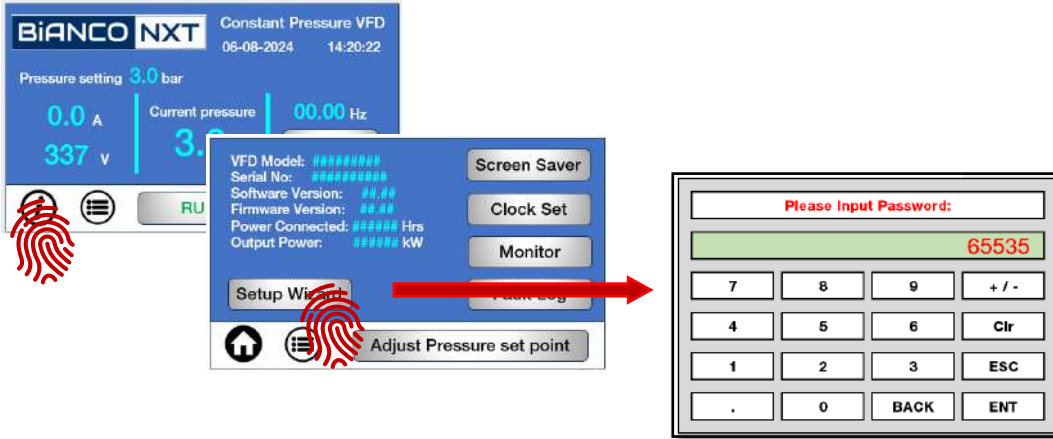

Setup wizard: Constant Pressure, Sleep Enabled, Auto Restart

Pump Group #1	Nameplate kW	###	Rated kW
Pump Group #4	Nameplate Voltage	###	Rated Voltage
Pump Group #3	Rated Motor Speed	####	RPM
Pump Group #5	Rated Current	##	Amp
Pump Group #13	Max Hz	##	Hz

In most cases, for a single Pump / Master DRIVE arrangement, after connecting the pressure transducer tuning the setup wizard is all that is required.

Pump Group #15	Upper Limit Hz	50	Hz
Press Group #10	Sleep Option	1	0 = Off. 1 = On
Press Group #11	Sleep Freq	30	Hz
Press Group #7	Sleep detect time	30	Sec
Press Group #26	Sleep Delay	1.0	0.1 - 200.0 sec
Pump Group #25	Auto-Start Option	0	0 = Not allowed 1 = Start when power on

Check and alter every setting as necessary.

Pump Group #15	Minimum Hz	30	Hz
Pump Group #6	Motor Direction	0	0 = Forward 1 = Reverse 2 = Not allowed
Pump Group #11	Acceleration time	8	Seconds
Pump Group #12	Deceleration time	8	Seconds
Pump Group #8	Low V Protection	85%	70.0 - 100.0%
Press Group #8	W.S. detect mode	###	0 = Off 1=By Current 2=By Press 3= Current&Press 4=Terminal

For Multi-Pump / Multi DRIVE systems, the Master Drive and Standby Master both require a transducer connected.

Press Group #15	W.S detect value	0.5	Bar
Press Group #17	W.S. detect time	50	Sec
Press Group #19	H.P. alarm	15	Bar
Press Group #20	H.P. detect time	3	Sec
Press Group #18	W.S. detect current	###	Amps (suggest 85% FLC)
End of setup wizard			

The Master Drive requires every Wizard setting checked and altered. The Standby Master and Slave Drives require ONLY the parameters highlighted in the green boxes altered

20. Setup quick guide – Bore pump, constant pressure (4-20mA input)

Bore motors with Kingsbury type thrust bearings: Set acceleration / deceleration to 0.1sec

21. Setup quick guide – Dual pumpset, constant pressure

Drive type	Comm Group:	Parameters setting
Master drive 1	Frequency Given: Default	1 = PID
	Comm. address	1
	Follower qty	1
Standby Master Drive 2	Start/stop command:	2
	Frequency given	2
	Comm. address	2

22. Setup quick guide – Triple pumpset, constant pressure

Drive type	Comm Group:	Parameters setting
Master drive 1	Frequency Given: Default	1 = PID
	Comm. address	1
	Follower qty	2
Standby Master Drive 2	Start/stop command:	2
	Frequency given	2
	Comm. address	2
Slave 1 Drive 3	Start/stop command:	2
	Frequency given	2
	Comm. address	3

23. Setup quick guide – ‘Soft Start’ without pressure control

Disable transducer setting

PRESSURE GROUP / Parameter #3 [Sensor Type]: Set to 0 (0-10V)

I/O GROUP / Parameter 11 [Di 1 Option]: Set to the preferred start method.

6 = Keypad Command

7 = Terminal Command

8 = Comm command

Set Acceleration / Deceleration times:

Centrifugal Pump: 5 – 8 sec accel / decel recommended

Set to 0.1 for bore motors with Kingsbury type thrust bearing

24. Setup quick guide – Speed control via external input

0.75 and 2.2kW BIA DRIVES

Pump Group

- Start /Stop command: = 1
- Frequency given: = 3 (0-10V) ,
- Connect external device(s) to Di1 and GND



4.0kW BIA DRIVES and larger

Pump Group

- Start /Stop command: = 1,
- Frequency given: = 4 (4-20mA)
- Connect external device(s) to Di1 and GND

25. Appendix 1: Pressure Group Parameter List

Pressure Group: 34 parameters, 6 pages			
Item	Function	Set Range	Default
1	Set Press	0.0 - 60.0 Bar	3.0 Bar
2	Start Press	0 – U0 - 00 Bar	2.4 Bar
3	Sensor Type	0 = (0 - 10V) 1 = (4-20mA) 5 = (4-20mA)	1
4	Sensor Range	0.0 - 60.0 Bar	10.0 Bar
5	Press. correct	0 - 2.000	1.000
6	Frequency drop time	0.0 – 100 (0 = Off)	1
7	Sleep Detect Time	3 – 6000 sec	30 sec
8	Water shortage detect mode	0 = Off 1 = By Current 2 = By Press. 3 = By Current and Press. 4 = Terminal	2
9	Leakage factor	0 – 10.0	1.0
10	Sleep Option	0 = OFF 1 = ON	1
11	Sleep Frequency	0.00Hz – 100 Hz	35.00 Hz
12	Anti-freezing / rust	0 = OFF 1 = ON	1
13	Sensor off value	0.0 - 100.0%	5.0
14	Sensor off time	0.0 - 3000.0 sec	10.0 sec
15	Water shortage detect value	0 – 200 Bar (Low pressure setting)	0.5 Bar
16	Water shortage freq.	00.00 - 99.99 Hz	45.00 Hz
17	Water shortage delay	0.1 - 999.9 sec	50.0 sec
18	Water shortage Current.	Model Dependent	Amps
19	High Pressure alarm	0 - 200.0 Bar	15.0 Bar
20	High Pressure detect time	0.1 - 200.0 sec	3.0 sec
21	Water shortage alarm	0.0 - 60.0 Bar	0 Bar
22	L.P. detect time	0.1 - 6000.0 sec (Low pressure)	60.0 sec
23	Anti freezing cycle	3 - 60000 min	1500 min
24	Anti freezing time	0 - 6000 sec	10 sec
25	Anti freezing freq.	00.00 - 99.99 Hz	30.00 Hz
26	Sleep Delay	0.1 - 200.0 sec	1.05 sec
27	Kp1	0.0 - 50.0	3.0
28	Integral Time 1	0.1 - 100.0 sec	1.0 sec
29	Kp2	0.0 - 50.0	3.0
30	Integral Time 2	0.1 – 100.0 sec	2.0 sec
31	PID Change Deviation	0 – 100%	50%
32	Alarm reset occurrences	0 – 1000	200
33	Alarm reset time	0 – 60000 min	10 min
34	Alarm reset Option	0 = OFF 1 = ON	111

26. Appendix 2: Comm Group Parameter List

Communication Group: 10 parameters, 2 pages			
Item	Function	Set Range	Default
1	Comm Address	1,2 for master; 3-5 for slave	1
2	Alternation Time	0-60000 Min	480 min
3	Slave Qty	0 - 4	0
4	Multi pump control	0 = Master/slave control 1 = Simultaneous	0
5	Pump adding delay	0.1-600.0 sec	1.0 sec
6	Pump reducing delay	0.1-600.0 sec	0.1 sec
7	Standby Pump delay	0.1-600.0 sec	5.0 sec
8	Baud Rate for Comm	5 = 9600 6 = 19200 7 = 38400	6
9	External address	0 - 247	1
10	External baud rate	5 = 9600 6 = 19200 7 = 38400	5

27. Appendix 3: Pump Group Parameter List

Pump Group 32 parameters, 6 pages			
Item	Function	Set Range	Default
1	Initialization	0 - 9999	0
2	Motor Rated Power	1 - 1000 kW	Set according to motor nameplate
3	Motor Rated Speed	1 - 10000 rpm	
4	Motor Rated Voltage	1 - 800 V	
5	Motor Rated Current	01 - 1000.0 A	
6	Rotation Direction	0 = Forward 1 = Reverse 2 = Not allowed	0
7	Stop method	0 = Stop by deceleration 1 = Natural Stop	0
8	Low voltage Protection	70.0 -100.0 %	100.00%
9	Stop and start command	0 = Keypad 1 = Terminal 2 = Communication	2
10	Frequency given	0 = UO-14 1= PID 2 = Com. (Slave Com2) 3 = External control (0-10v) 4 = External control (4 – 20 mA) 5 = C1 (4 – 20mA)	1
11	Acceleration time	0.1 - 6000.0 S	8.0 sec
12	Deceleration time	0.1 - 6000.0 S	8.0 sec
13	Max Frequency	5.00 – 200Hz	50.00 Hz
14	Upper limit Frequency	5.00 – 200Hz	50.00 Hz
15	Lower limit Frequency	5.00 – 200Hz	0.0 Hz
16	Hand Input Frequency	0.00 – 200Hz	50.00 Hz
17	Carrier Frequency	1 - 12	6
18	Output phase loss protection	0 = Off 1 = On	1
19	Motor overload Gain Protection	20.0 – 1000.0%	100.0%
20	Torque Boost	0 - 20%	Model dependent
21	GND short circuit protection	0 = Off 1 = On	1
22	Overcurrent stall gain	0-100.0 sec	20 sec
23	Overcurrent stall current	100.0 - 200.0%	160.0%
24	Overvoltage stall / Overvoltage protection	110 – 145%	130%
25	Auto Start option	0 = Not allowed 1 = start when power on	0
26	Auto Start delay when power is on	0 – 100.0 sec	1.0 sec
27	Fault Reset attempts	0 - 20	3
28	Fault Reset Time	0.1-100.0 sec	10.0 sec
29	Quick reducing Current	0 = Off 1 = On	1
30	Input phase loss protection	0 = Off 1 = On	1
31	Motor type selection	0 = Asynchronous motor 1 = Permanent magnet synchronous	0
32	Motor rated Frequency	50 Hz	Set according to motor nameplate

28. Appendix 4: I/O Group Parameters

Input / Output Group 25 parameters, 5 pages			
Item	Function	Set Range	Default
1	Min V	0.00 – 10.00	0.00
2	Min V Freq	0.0 – 100%	0.0%
3	Max V	0.00 – 10.00	10.00
4	Max V Freq	0.0 – 100%	100%
5	V Filter time	0.01 – 10.00 sec	0.05 sec
6	Min C	0.00 – 20.00	4.0
7	Min C Freq	0.0 – 100.0%	0.0%
8	Max C	0.00 – 20.00	20.00
9	Max C Freq	0.0 – 100.0%	100.0%
10	C Filter time	0.01 – 10.00 sec	0.05 sec
11	Di 1 Option	0 = Disabled 1 = Forward 2 = Reverse 3 = Fault input 4 = Haste stop 5 = Reset 6 = PIO closed 7 = Keypad command 8 = Terminal command 9 = Com command 10 = Fault input is constantly closed 11 = Water shortage	11
12	Di 2 Option		
13	Di 3 Option		
14	Mo Output	0 = Disabled 1 = Run Status 2 = fault 3 = FDT1 4 = FOT2 5 = Run at 0 freq. 6 = Lower limit freq. run 7 = Upper limit freq run 8 = Standby 9 = Sleep 10 = Temp Arrival	11
15	Relay (TA, TB, TC)		
16	Relay (TA1, TB1, TC1)		
17	Di1 valid delay	0.0 – 3600.0 sec	0.0 sec
18	Di1 invalid delay	0.0 – 3600.0 sec	0.0 sec
19	Di2 valid delay	0.0 – 3600.0 sec	0.0 sec
20	Di2 invalid delay	0.0 – 3600.0 sec	0.0 sec
21	Di3 valid delay	0.0 – 3600.0 sec	0.0 sec
22	Di3 invalid delay	0.0 – 3600.0 sec	0.0 sec
23	MO output delay	0.0 – 3600.0 sec	0.0 sec
24	Relay Delay	0.0 – 3600.0 sec	0.0 sec
25	Relay1 Delay	0.0 – 3600.0 sec	0.0 sec

29. Appendix 5: Alarm Codes and Solutions

Common alarm codes and Solutions

Alarm Description	Possible Reasons	Solutions
Low Flow Prot	<ol style="list-style-type: none"> 1. Low inlet flow. 2. Drive's power is bigger than that of pump, Water pressure below 0.5 bar. 3. Low water press. set too high. 	<ol style="list-style-type: none"> 1. Increase incoming water 2. Low flow detect mode set 2 3. Decrease low water protection current
H.P. Prot	<ol style="list-style-type: none"> 1. Actual pressure exceeds 15bar 2. Sensor malfunction, the readout exceeds 15 bar 	<ol style="list-style-type: none"> 1. Actual pressure exceeds 15bar 2. Sensor malfunction, the readout exceeds 15 bar
L.P. Prot	<ol style="list-style-type: none"> 1. Pressure below 0.5 bar 2. Pressure below 0.5 bar while pump rotates reversely. 3. Water consumption is bigger than outlet flow. 4. Low press alarm set too high 	<ol style="list-style-type: none"> 1. Remove the air in the pump. 2. Adjust rotation direction. 3. Increase the inlet flow 4. Replace with bigger size pump or reduce water consumption. 5. Lower the alarm set value
Low Cur. Prot	<ol style="list-style-type: none"> 1. Incoming water shortage. 2. Drive's power is bigger than that of pump. 3. Low water detecting current is set high 	<ol style="list-style-type: none"> 1. Increase incoming water 2. Low flow detect mode set 2 3. Decrease low water protection current

Faults and Trouble Shooting

Fault Type	Possible Reasons	Solutions
O/P SCC	<ol style="list-style-type: none"> 1. short circuit or connected to ground 2. Overload 	<ol style="list-style-type: none"> 1. Inspect wiring 2. Contact factory
Accel OC	<ol style="list-style-type: none"> 1. Short acceleration time 2. High Torque boost or V/F curve is not applicable 	<ol style="list-style-type: none"> 1. Increase acceleration time 2. Lower torque boost, Increase volt, Adjust V/F curve
Decel OC	Short deceleration time	Increase deceleration time
Run OC	Load sharply change	Reduce load fluctuation
SWOC	Software Overcurrent	Alter PID values
Internal Fault	Hardware problems	Contact factory
GND Fault	<ol style="list-style-type: none"> 1. Drive or motor output is connected to ground 2. Drive input connected to output 	<ol style="list-style-type: none"> 1. Inspect wiring 2. Inspect motor aging problems.
Accel OV	<ol style="list-style-type: none"> 1. High input voltage 2. Frequent switching on and off 	Inspect the power and Voltage
Decel OV	<ol style="list-style-type: none"> 1. Short decel. time 2. Abnormal input voltage. 	<ol style="list-style-type: none"> 1. Increase decel. time 2. Inspect power voltage 3. Reinstall brake resistor
Run OV	<ol style="list-style-type: none"> 1. Abnormal input voltage. 2. Feedback energy 	<ol style="list-style-type: none"> 1. Inspect power 2. Reinstall brake resistor

Faults and Trouble Shooting Con't

Underload Prot	1. Drive output virtual wiring 2. No load	1. Inspect wiring 2. Inspect load
Drive OL	1. Excessive electrical load 2. Short acceleration time 3. High torque increase or V/F curve not applicable 4. Low Grid voltage	1. Reduce load or replace with a higher output drive 2. Increase accel. time 3. Lower torque. Increase voltage, adjust V/F curve. 4. Check grid voltage
Motor OL	1. Too big load 2. Too short acceleration time 3. Protection value is too small 4. Torque increases too high or V/F curve not applicable	1. Reduce load or replace with a higher output drive 2. Increase acceleration time 3. Increase overload protection value 4. Lower torque. Increase voltage to adjust V/F curve
Current detection fault	1. Damage of detecting device or circuit fault 2. Auxiliary power problems	Contact Factory
Low Volt Run	1. Abnormal input voltage 2. Big load in power grid	1. Inspect power voltage 2. Detach electricity supply
Open Terminal	External devices fault, input signal exist	Inspect the signal and its related devices
Closed Terminal	External devices fault, input signal exist	Inspect the signal and its related devices
Drive overheat	1. Dust 2. High envir. temp. 3. Fan damaged	1. Clean up air duct 2. Lower carrier frequency 3. Replace fan
I/P phase loss	1. Input voltage phase loss 2. Input voltage is too low	1. Check input wires connection 2. Check grid phase loss
O/P Phase loss	Bad correction of drive to motor	Inspect wiring
Storage Faults	Hardware Fault	Contact Factory
Running time reaches set time	Running time reaches set time	Contact factory
Sensor Fault	1. PID signal is off 2. Sensor is broken 3. Sensor setting problem	1. Check feedback channel 2. Check sensor has fault or not. 3. Check if the feedback signal complies with setting
Comm Fault	Data sending or receiving is incorrect	1. Check wiring 2. Contact manufacturer
Interfere fault	Improper operation caused by the surrounding EMI	Use absorption circuit to eliminate the surrounding interference

30. Warranties – Terms and Conditions

This warranty is given in addition to the consumer guarantees found within the Australian Competition and Consumer Act 2010 (Cth) for goods purchased in Australia and the Consumer Guarantees Act 1993 NZ for goods purchased in New Zealand:



1) White International Pty Ltd / White International NZ Ltd (White International) warrant that all products distributed are free from defects in workmanship and materials, for their provided warranty period as indicated on the top or opposite side of this document. Subject to the conditions of the warranty, White International will repair any defective products free of charge at the premises of our authorised service agents throughout Australia and New Zealand if a defect in the product appears during the warranty period. If you believe that you have purchased a defective product and wish to make a claim under this warranty, contact us on our Sales Hotline on 1300 783 601, or send your claim to our postal address or fax line below and we will advise you as to how next to proceed. You will be required to supply a copy of your proof of purchase to make a claim under this warranty.

2) This warranty excludes transportation costs to and from White International or its appointed service agents and excludes defects due to non-compliance with installation instructions, neglect or misuse, inadequate protection against the elements, low voltage or use or operation for purposes other than those for which they were designed. For further information regarding the suitability of your intended application contact us on our Sales Hotline on 1300 783 601. If you make an invalid claim under this warranty, the original product will be sent back to you unrepai red.

3) This warranty refers only to products sold after the 1st January 2012, and is not transferable to another product type and only applies to the original owner, purchaser or end user, and is in addition to the consumer guarantees found within the Competition and Consumer Act 2010 (Cth) for goods purchased in Australia and the Consumer Guarantees Act 1993 (NZ) for goods purchased in New Zealand.

4) Our goods come with guarantees that cannot be excluded under the Australian Consumer Law. You are entitled to a replacement or refund for a major failure and for compensation for any other reasonably foreseeable loss or damage. You are also entitled to have the goods repaired or replaced if the goods fail to be of acceptable quality and the failure does not amount to a major failure. 2 YEAR WARRANTY

5) To the fullest extent permitted by law, White International excludes its liability for all other conditions or warranties which would or might otherwise be implied at law. To the fullest extent permitted by law, White International's liability under this warranty and any other conditions, guarantees or warranties at law that cannot be excluded, including those in the Competition and Consumer Act 2010 (Cth), is expressly limited to: (a) in the case of products, the replacement of the product or the supply of equivalent product, the payment of the cost of replacing the product or of acquiring an equivalent product or the repair of the product or payment of the cost of having the product repaired, is at the discretion of White International or a 3rd party tribunal elected under the Competition and Consumer Act 2010 (Cth) for goods purchased in Australia and the Consumer Guarantees Act 1993 (NZ) for goods purchased in New Zealand; and

6) To the fullest extent permitted by law, this warranty supersedes all other warranties attached to the product or its packaging.

7) In the case of services, supplying the services again or the payment of the cost of having the services supplied again, is at the discretion of White International or a 3rd party tribunal elected under the Competition and Consumer Act 2010 (Cth) for goods purchased in Australia and the Consumer Guarantees Act 1993 (NZ) for goods purchased in New Zealand. 8) Our warranty commences from the date of purchase of the above mentioned pumps. Proof of purchase is required before consideration under warranty is given.

Record your date of purchase in the space below and retain this copy for your records.

Date of Purchase**Model Purchased**



www.whiteint.com.au

www.whiteint.co.nz

Please always refer to our website for further technical information & new product innovations

Disclaimer: Every effort has been made to publish the correct information in this manual. No responsibility will be taken for errors, omissions or changes in product specifications.

© 2024 Copyright White International Pty Ltd

TM ® - WARNING: Please be aware that various brands & products depicted within this document are subject to trademark, patent or design registrations. Infringement of any intellectual property contained within this document without express written authority by the appropriate intellectual property holder may result in further legal action to be taken. For any queries regarding use of the contained information please feel free to contact White International Pty Ltd.